

Small Hole Gauges



SIZES AVAILABLE
3-13mm
Qty.: Set of 4 pcs.

Telescoping Gauges



SIZES AVAILABLE
8-150mm
Qty.: Set of 6 pcs.

Straight Edge



SIZES AVAILABLE (L x W x H)
1,000 x 10 x 50mm • 1,500 x 12 x 60mm
2,000 x 12 x 60mm • 3,000 x 20 x 100mm

Steel Rulers



SIZES AVAILABLE
15cm / 6" • 30cm / 12" • 60cm / 24" • 100cm / 40"
120cm / 48" • 200cm / 80"

Oil Tapes



ALUMINIUM FRAME WITH
RUBBER GRIPPED
ABS PLASTIC HANDLE



ABS PLASTIC FRAME

SIZES AVAILABLE
Carbon Steel & Stainless Steel
10mts • 15mts • 20mts • 30mts • 50mts • 100mts • 200mts
Blade Width : 13mm
Plumbobs Available : 100mm & 150mm Brass / Stainless Steel

Oil Tape Refills



CARBON STEEL REFILL

STAINLESS STEEL REFILL
(MATT FINISH)

STAINLESS STEEL REFILL
(BRIGHT FINISH)

SIZES AVAILABLE
Carbon Steel & Stainless Steel
10mts • 15mts • 20mts • 30mts • 50mts • 100mts • 200mts
Blade Width : 13mm

Plumbobs



150 mm
S.S.
PLUMBLOB

150 mm
BRASS
PLUMBLOB

100 mm
S.S.
PLUMBLOB

100 mm
BRASS
PLUMBLOB

Steel Tapes



Y-16
3mts x16mm



FLY-16
3mts x16mm

Spirit Levels



TRIO

PICCOLO

SIZES AVAILABLE
TRIO : 200mm • 300mm • 450mm • 600mm • 1,000mm
1,200mm • 1,500mm • 2,000mm
PICCOLO : 300mm • 450mm • 600mm

Fibre Glass Tapes

COBRA
ABS PLASTIC CASE

SIZES AVAILABLE
10mts • 15mts • 30mts • 50mts
Blade width: 12.7mm



ABS PLASTIC CASE OPEN TYPE

SIZE AVAILABLE
100mts
Blade width: 12.7mm

AUTHORISED DISTRIBUTOR

Models and Specifications are subject to change without prior notice

Bliss
Classic+
MEASURING INSTRUMENTS
by YAMAYO®

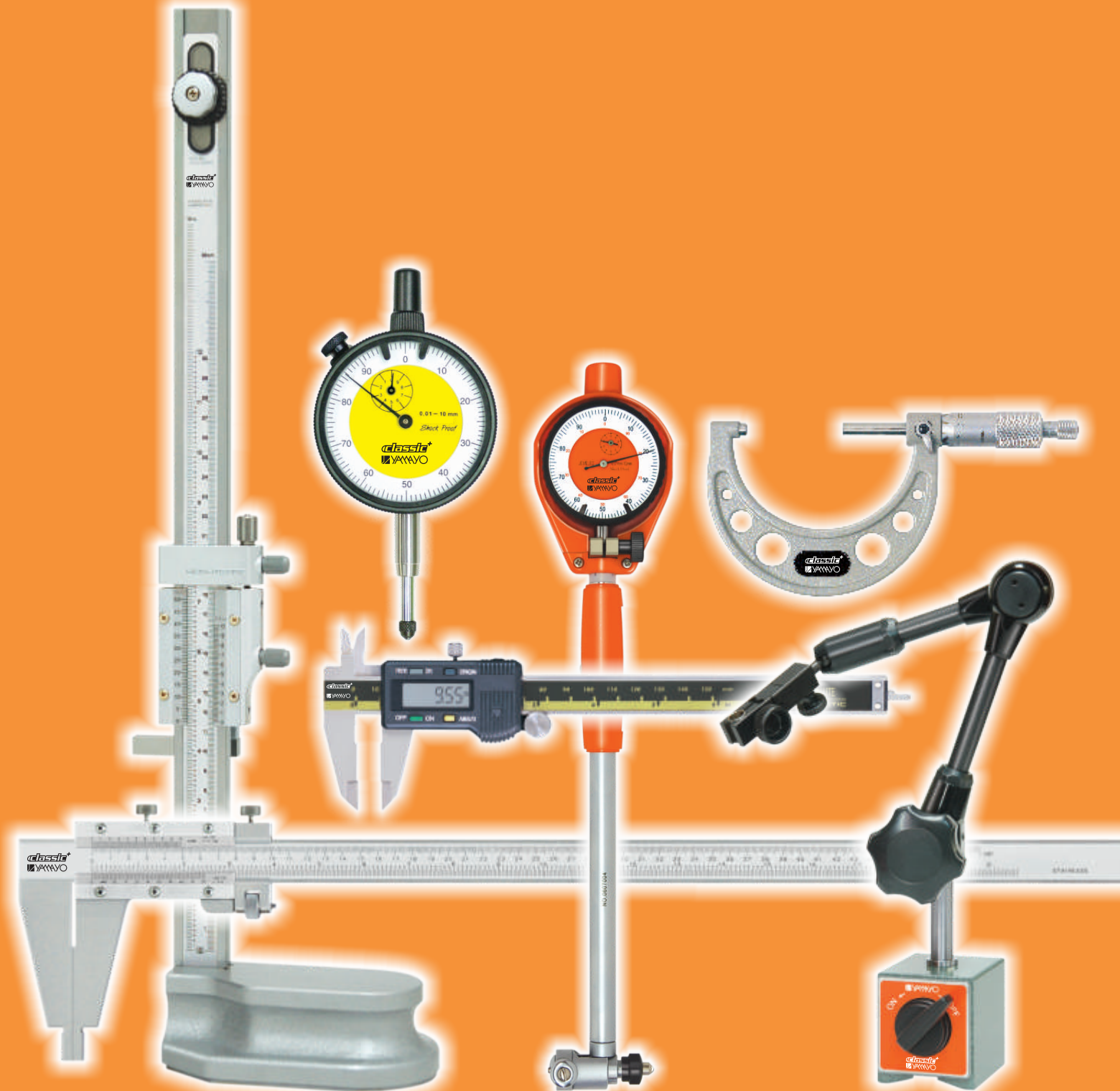

Vernier Calipers

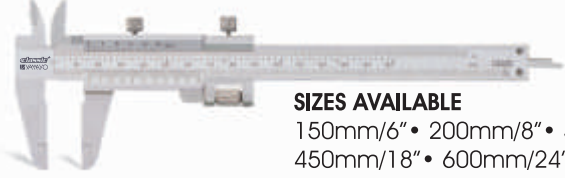

SIZES AVAILABLE
150mm/6" • 200mm/8" • 300mm/12"
450mm/18" • 600mm/24"
Vernier Reading: 0.02mm/0.001"

Vernier Calipers without Fine Adjustment



SIZES AVAILABLE
150mm/6" • 200mm/8" • 300mm/12"
Vernier Reading: 0.02mm/0.001"

Carbide Jaws Type Calipers

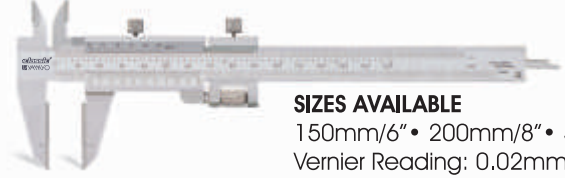

SIZES AVAILABLE
150mm/6" • 200mm/8" • 300mm/12"
Vernier Reading: 0.02mm/0.001"

Heavy Duty Vernier Calipers



SIZES AVAILABLE
300mm/12" • 450mm/18"
600mm/24" • 1,000mm/40"
1,500mm/60" • 2,000mm/80"
Vernier Reading: 0.02mm/0.001"

Heavy Duty Solid Type Vernier Calipers



SIZES AVAILABLE
450mm/18" • 600mm/24"
1000mm/40" • 1500mm/60"
Vernier Reading: 0.02mm/0.001"

Long Jaws Solid Type Vernier Calipers



SIZES AVAILABLE
300mm/12" • 600mm/24"
1000mm/40"
Vernier Reading: 0.02mm/0.001"

Dial Calipers



SIZES AVAILABLE
150mm • 200mm • 300mm
450mm • 600mm • 1000mm
Vernier Reading: 0.02mm
150mm • 200mm • 300mm
Vernier Reading: 0.05mm
150mm • 200mm • 300mm
Vernier Reading: 0.01mm
6" • 8" • 12"
Vernier Reading: 0.001"

Dial Calipers with New Design Golden Dial



SIZES AVAILABLE
150mm • 200mm
Vernier Reading: 0.02mm

Digimatic Calipers with Dust/Water Protection Confirming to IP65 Level

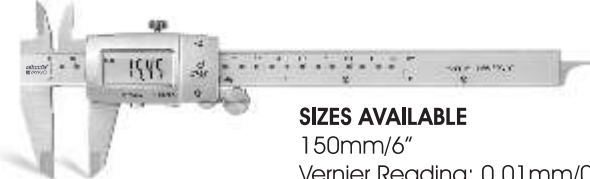

SIZES AVAILABLE
150mm/6"
Vernier Reading: 0.01mm/0.0005"

Digimatic Calipers



SIZES AVAILABLE
150mm/6" • 200mm/8" • 300mm/12"
Vernier Reading: 0.01mm/0.0005"

Heavy Duty Digimatic Calipers



SIZES AVAILABLE
600mm/24" • 1000mm/40"
Vernier Reading: 0.01mm/0.0005"

Digimatic Calipers with Carbide Jaws



SIZES AVAILABLE
150mm/6"
Vernier Reading: 0.01mm/0.0005"

Fraction Digimatic Calipers



SIZES AVAILABLE
150mm/6"
Vernier Reading: 0.01mm/0.0005"

Vernier Depth Calipers

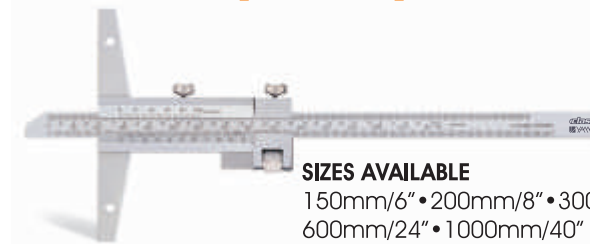

SIZES AVAILABLE
150mm/6" • 200mm/8" • 300mm/12"
600mm/24" • 1000mm/40"
Vernier Reading: 0.02mm/0.001"

Digimatic Depth Calipers



SIZES AVAILABLE
150mm/6" • 200mm/8" • 300mm/12"
Vernier Reading: 0.01mm/0.0005"

Gear Tooth Vernier Calipers



SIZES AVAILABLE
Module 1-26mm
Graduation 0.02mm

Vernier Height Gauges

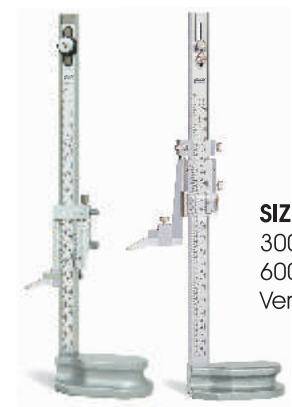

SIZES AVAILABLE
300mm/12" • 450mm/18"
600mm/24" • 1000mm/40"
Vernier Reading: 0.02mm/0.001"

Digit Dial Height Gauges



SIZES AVAILABLE
300mm • 600mm
Dial Reading: 0.01mm

Digimatic Height Gauges



SIZES AVAILABLE
300mm/12" • 600mm/24"
Resolution: 0.01mm/0.0005"

Single Beam Digimatic Height Gauges



SIZES AVAILABLE
300mm/12" • 600mm/24"
Resolution: 0.01mm/0.0005"

Digimatic Micrometers



SIZES AVAILABLE
0-25mm / 0-1" • 25-50mm / 1-2"
50-75mm / 2-3" • 75-100mm / 3-4"
Resolution: 0.001mm / 0.00005"

Outside Micrometers



SIZES AVAILABLE
METRIC: From 0-25mm to 275-300mm with 25mm increment
Graduation: 0.01mm
Optional Graduation available for sizes from 0-25mm to 75-100mm: 0.001mm
INCH: From 0-1" to 7-8" with 1" increment • Graduation: 0.001"
Optional Graduation available for sizes from 0-1" to 3-4": 0.0001"

Digit Micrometers

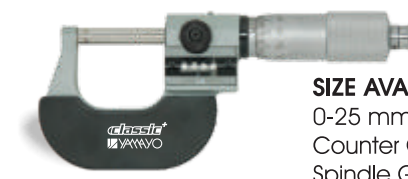

SIZE AVAILABLE
0-25 mm, 25-50 mm
Counter Graduation: 0.01 mm
Spindle Graduation: 0.001 mm

Interchangeable Micrometers

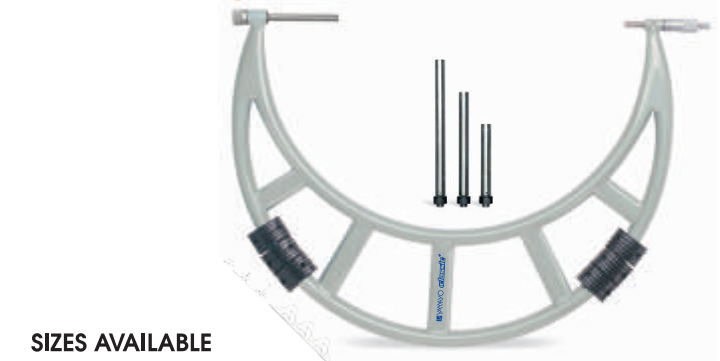

SIZES AVAILABLE
300-400mm • 400-500mm • 500-600mm • 600-700mm
700-800mm • 800-900mm • 900-1000mm
Graduation: 0.01mm
Available with interchangeable Anvils: 0, 25, 50, 75mm

Adjustable Outside Micrometers

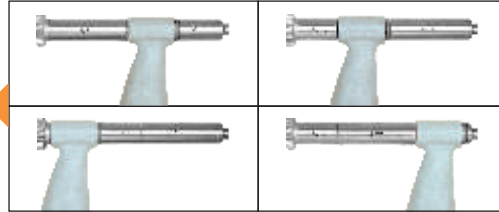

SIZES AVAILABLE
 300-400mm • 400-500mm • 500-600mm • 600-700mm
 700-800mm • 800-900mm • 900-1000mm • 1000-1200mm
 1200-1400mm • 1400-1600mm • 1600-1800mm • 1800-2000mm
 Graduation: 0.01mm

Digimatic Interchangeable Micrometers



SIZES AVAILABLE
 300-400mm • 400-500mm • 500-600mm • 600-700mm
 700-800mm • 800-900mm • 900-1000mm
 Graduation: 0.001mm
 Available with interchangeable Anvils: 0, 25, 50, 75mm

Digimatic Interchangeable Outside Micrometers

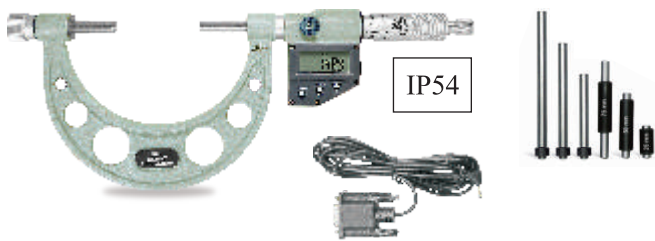

SIZES AVAILABLE
 0-100mm/0-4" • 50-150mm/2-6" • 100-200mm/4-8"
 0-150mm/0-6" • 150-300mm/6-12"
 Graduation: 0.001mm/0.00005"

Interchangeable Outside Micrometers



SIZES AVAILABLE
 METRIC: 0-50mm • 0-100mm • 0-150mm
 • 50-150mm • 100-200mm • 150-300mm • 200-300mm
 Graduation: 0.01mm
 INCH: 0-2" • 0-4" • 0-6" • 2-6" • 4-8" • 6-12"
 Graduation: 0.001"

Disc Micrometers



SIZES AVAILABLE
 0-25mm to 175-200mm
 with 25mm increment
 Graduation: 0.01mm

Screw Thread Micrometers



SIZES AVAILABLE
 0-25mm • 25-50mm
 Graduation: 0.01mm

Blade Outside Micrometers

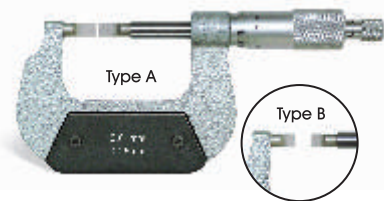

SIZES AVAILABLE
 0-25mm to 75-100mm
 with 25mm increment
 Graduation: 0.01mm

Tube Outside Micrometers

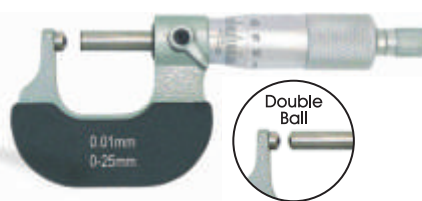

SIZES AVAILABLE
 Single Ball: 0-25mm
 Double Ball: 0-25mm
 Graduation: 0.01mm

Point Micrometers

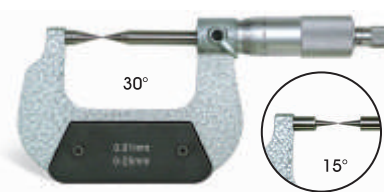

SIZES AVAILABLE
 0-25mm with 15°/30° point
 Graduation: 0.01mm

Crimp Height Micrometers



SIZES AVAILABLE
 0-25mm
 Graduation: 0.01mm

Micrometer Stand



Depth Micrometers



SIZES AVAILABLE
 0-25mm • 0-50mm
 0-100mm • 0-150mm
 Graduation: 0.01mm
Available
 Base length:
 63mm • 101.5mm

Digimatic Depth Micrometers



SIZES AVAILABLE
 0-25mm • 0-50mm
 0-100mm • 0-150mm
 Graduation: 0.001mm
Available
 Base length:
 101.5mm

Groove Micrometers



SIZES AVAILABLE
 0-25mm with Flange Diameter 6.50mm / 13mm
 Graduation: 0.01mm

Jaw Type Inside Micrometers



SIZES AVAILABLE
 5-30mm • 25-50mm • 50-75mm • 75-100mm
 Graduation: 0.01mm

Tubular Inside Micrometers



SIZES AVAILABLE
 50-300mm • 50-500mm • 50-1000mm • 50-1500mm
 Graduation: 0.01mm

Inside Micrometers Rod Type



SIZES AVAILABLE
 25-50mm • 50-200mm
 50-300mm
 Graduation: 0.01mm

Dial Caliper Gauges



SIZES AVAILABLE
 5-25mm • 10-30mm
 20-40mm • 40-60mm
 Graduation: 0.01mm

Outside Pistol Caliper Gauges



SIZES AVAILABLE
 0-20mm
 Graduation: 0.01mm

Inside Pistol Caliper Gauges



SIZES AVAILABLE
 15-35mm • 35-55mm
 55-75mm • 75-95mm
 95-115mm • 115-135mm
 Graduation: 0.01mm

Dial Bore Gauges

Ceramic Tip



SIZES AVAILABLE

6-10mm • 10-18.5mm
18-35mm • 35-60mm
50-150mm • 160-250mm
250-450mm
Dial Indicator provided
(Graduation): 0.01mm

Dial Indicators



SIZES AVAILABLE

0-1mm Graduation: 0.001mm
0-5mm • 0-10mm • 0-25mm Graduation: 0.01mm

Double Face Dial Indicators



SIZES AVAILABLE

0-10mm
Graduation: 0.01mm

Durometer



Shore A
Range: 0-100 HA

Digimatic Indicators



SIZES AVAILABLE

0-12.7mm / 0-0.5" Resolution: 0.001mm / 0.00005"
0-12.7mm / 0-0.5" Resolution: 0.01mm / 0.0005"

Dial Test Indicators



SIZES AVAILABLE

0-0.8mm, 0-0.2mm
Resolution: 0.01mm, 0.002mm
Dial Diameter: 40mm, 30mm

Magnetic Stands



7010 S

7011 S

7014 S

7012



7019 B



7027



7017

P Type Dial Caliper Gauges



SIZES AVAILABLE

0-10mm
Graduation: 0.05mm
Arm Length: 40 & 70mm



BEZEL TYPE ARM

SIZES AVAILABLE
0-10mm
Graduation: 0.05mm

Dial Thickness Gauges



SIZES AVAILABLE

0-10mm
Graduation: 0.01mm

Digimatic Pye Tapes



SIZES AVAILABLE

Measuring Range:
Linear 0-13mm,
Radius 5-10,000mm
Resolution: 0.01mm / 0.0005"

Combination Square Sets

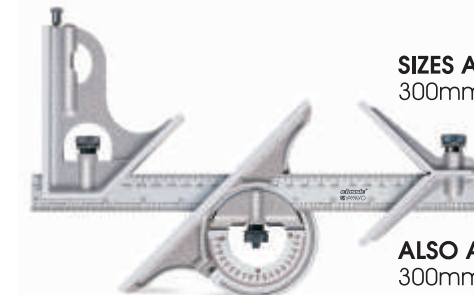

SIZES AVAILABLE

300mm / 12" • 600mm / 24"

ALSO AVAILABLE: Only Scale
300mm / 12" • 600mm / 24"

Bevel Protractors

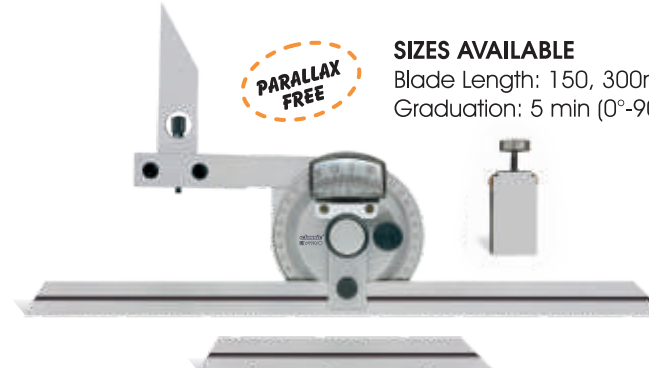

PARALLAX FREE

SIZES AVAILABLE

Blade Length: 150, 300mm
Graduation: 5 min (0°-90°-0°)

Digimatic Bevel Protractor



SIZES AVAILABLE

Graduation: 0-360°
Resolution: 1' / 0.01°

Digital Level



SIZES AVAILABLE

Graduation: 4 X 90°
Resolution: 0.1°
With Magnetic Base

Digital Protractor



SIZES AVAILABLE

0 - 360° (90° x 4)
Resolution: 0.05°

With Magnetic Base, IP65

Gauge Block Set



SETS AVAILABLE

112 pcs, 87 pcs
& 83 pcs
Available in Grade 2
& Grade 0

Linear Levels

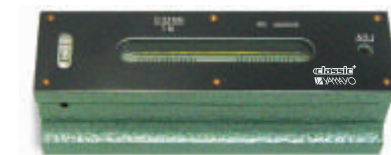

SIZE AVAILABLE

150mm, 200mm, 300mm
Accuracy: 0.02mm

Angle Gauge Set



SIZE AVAILABLE

5° - 90° by 5°
Qty.: Set of 18 pcs

Radius Gauges



SIZES AVAILABLE

0.5 - 15mm
Qty.: Set of 22 pcs.